

PLANTER BENCH



**SOUTHERN
FOREST PRODUCTS
ASSOCIATION**

6660 Riverside Dr., Suite 212
Metairie, LA 70003

SouthernPine.com
SouthernPineDecks.com

Planter Bench

Project Plan #851 Sheet 1 of 6

Copyright © 2016 Southern Forest Products Association. All rights reserved.

Outdoor accents to your deck or patio can be both comfortable and useful. A planter bench can function much like a sofa or end table indoors. And for building a sturdy, long-lasting piece of outdoor furniture, pressure-treated Southern Pine lumber is the perfect choice.

This plan will guide you through the construction process, step by step. When your project is complete, add your choice of plants and ornaments, have a seat, and enjoy your new addition to better outdoor living.

MATERIALS LIST

To build this planter bench, you will need the following quantities of pressure-treated Southern Pine lumber:

NUMBER OF PIECES	MATERIAL	LENGTH	SERVICE CONDITION
1	2x12	12'	Ground Contact
1	2x4	12'	Ground Contact
1	2x4	8'	Ground Contact
3	2x4	10'	Ground Contact
3	2x4	12'	Ground Contact
1	1x6	6'	Ground Contact

OTHER MATERIALS NEEDED

- 6d, 8d, 10d hot-dip galvanized or stainless steel nails (See Fastener Advisory)
- Construction adhesive for pressure-treated lumber.
- 2 heavy-duty plastic garbage bags, 20- or 30-gallon size, for planter liner.
- Water-repellent sealer

TOOLS REQUIRED

- Circular or crosscut saw
- Hammer
- Square
- Carpenter's rule or tape



SouthernPine.com
SouthernPineDecks.com

These plans and the information contained herein will help you achieve the best possible results in working with Southern Pine lumber products. The conditions under which lumber is used in construction vary widely, as does the quality of workmanship. Since neither the Southern Forest Products Association nor its members control the method of use or the quality of workmanship in structures built with lumber, they do not warrant lumber performance or design in completed structures.



6660 Riverside Dr., Suite 212
Metairie, LA 70003

SouthernPine.com
SouthernPineDecks.com

Planter Bench

Project Plan #851 Sheet 2 of 6

Copyright © 2016 Southern Forest Products Association. All rights reserved.

CONSTRUCTION STEPS

CUTTING

1. From the 12' 2x12, cut:
2 pieces 4'-4" long • 3 pieces 12¼" long
2. From the 12' 2x4, cut:
4 pieces 14¼" long • 2 Pieces 12¼" long • 3 pieces 16¼" long
3. From the 8' 2x4, cut:
5 pieces 18¼" long
4. From one 10' 2x4, cut:
1 piece 4'-10" long • 2 pieces 21¼" long
5. From the other 10' 2x4s, cut:
4 pieces 4'-7" long
6. From one 12' 2x4, cut:
1 piece 4'-8½" long • 4 pieces 21¼" long
7. From the second 12' 2x4, cut:
1 piece 3'-3½" long • 4 pieces 21¼" long
8. From the third 12' 2x4, cut:
1 piece 4'-7" long • 4 pieces 21¼" long
9. From the 6' 1x6, cut:
3 pieces 19¼" long

ASSEMBLY

1. Using 10d nails and construction adhesive, assemble bench frame with 2x12 pieces. Join one 12¼" piece flush with each end of the 4'-4" members. Attach 12¼" center support; refer to plan. Check to be sure frame is square.
2. Assemble bench seating deck. Attach four 2x4 cross members 1'-6¼" long to 2x12 frame using 8d nails and construction adhesive. Note from the plan how the two end cross members overhang 1½"; the other two cross members are evenly spaced between them.
3. Evenly space the five 2x4 decking members, each 4'-7" long, and attach to cross members using construction adhesive and 10d nails. Ends of the decking should be flush with the two end cross members. Refer to plan.
4. Using 8d nails and construction adhesive, attach the two 2x4 edge members, 1'-6¼" and 4'-10" long, to the perimeter of the seating deck.
5. Build the planter box frame using 8d nails and construction adhesive. Cut small weep hole openings in the two 2x4s 12¼" long as shown in the plan. Join these to the 16¼" 2x4 center support.
6. Attach four corner posts, 14¼" long, to 2x4 runners 16¼" long, as shown in the plan. Check to be sure frame is square.
7. Complete planter frame assembly by nailing three 1x6s, 19¼" long, to the runners and center support using 6d nails.
8. Note the stagger of 21¼" 2x4 edge members around the exterior of the planter. Start 1/4" above the bottom of the frame and attach four 2x4s using 8d nails and construction adhesive. Refer to plan.
9. Attach three more layers of 2x4 edge members around the planter frame, interlocking pieces at corner posts.
10. Join planter box and bench assemblies with their common 2x4 edge members, 4'-8½" and 3'-3½". Attach them to planter box first using 8d nails and construction adhesive. Move completed planter box into place and join edge members to 2x4 cross supports of bench.
11. Fabricate a liner for the planter box by double-bagging the two heavy-duty garbage bags. Roll down the top edges of both to form a collar of several thicknesses. From the leftover 1x6 material, cut 4 tacking blocks, each about 3½" long. Loosely fit the liner inside the planter, with the top collar about 1" below the rim. Nail the tacking blocks through the liner into the corner posts using 6d nails. Puncture liner bottom in line with the spaces between the 1x6 bottom members to permit the passage of moisture.
12. Apply a water-repellent sealer to all exposed wood surfaces now that construction is complete. Properly dispose of treated lumber scraps.

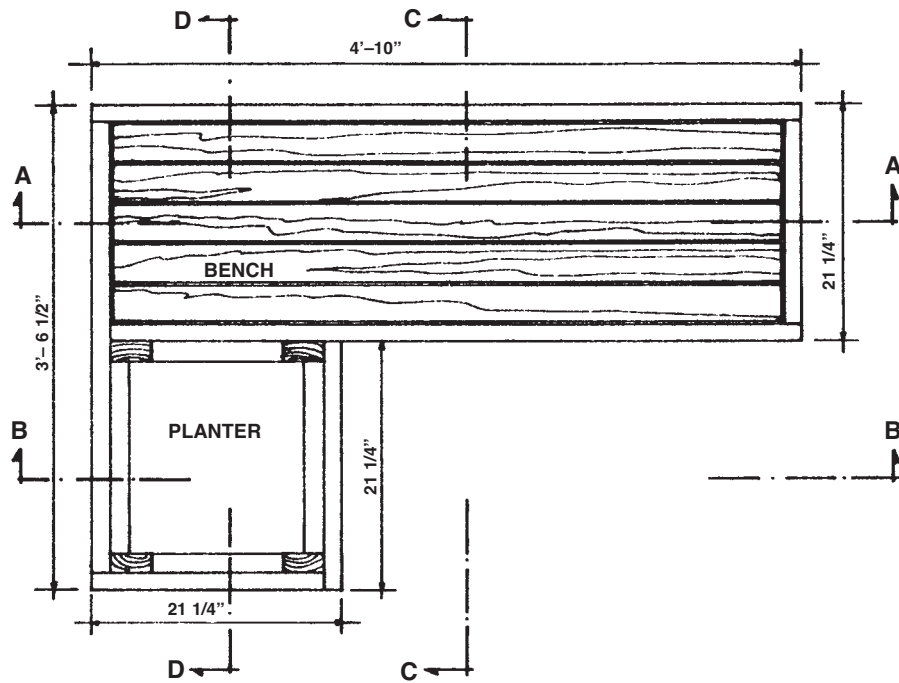

PLAN

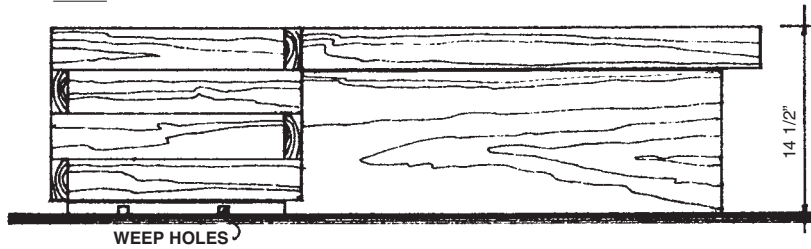

ELEVATION

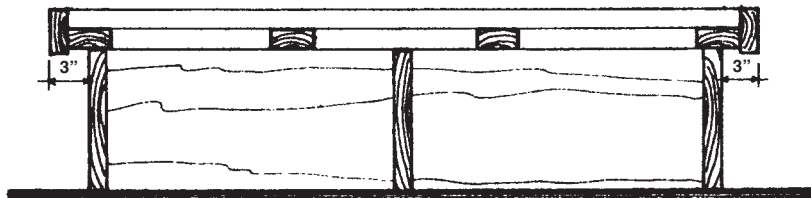

SECTION A-A

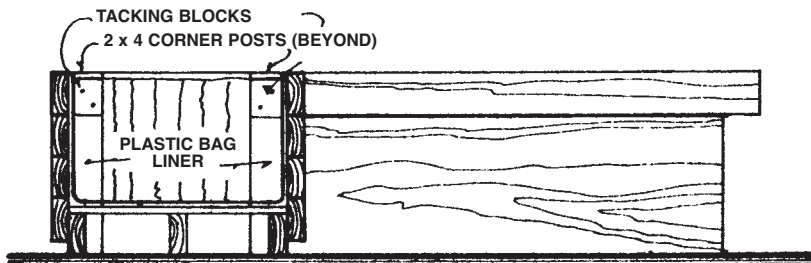

SECTION B-B



**SOUTHERN
FOREST PRODUCTS
ASSOCIATION**

6660 Riverside Dr., Suite 212
Metairie, LA 70003

SouthernPine.com
SouthernPineDecks.com

Planter Bench

Project Plan #851 Sheet 4 of 6

Copyright © 2016 Southern Forest Products Association. All rights reserved.

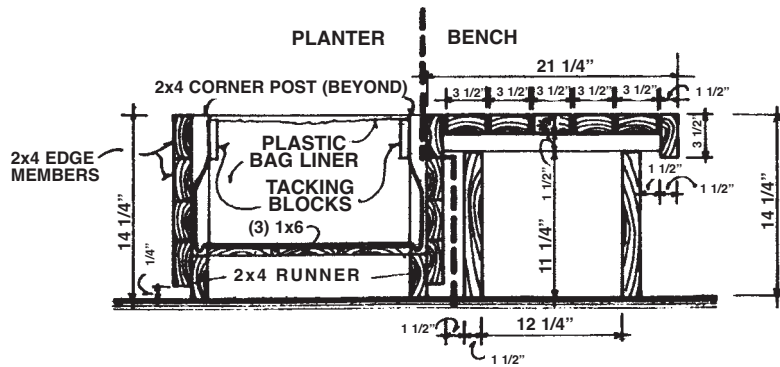
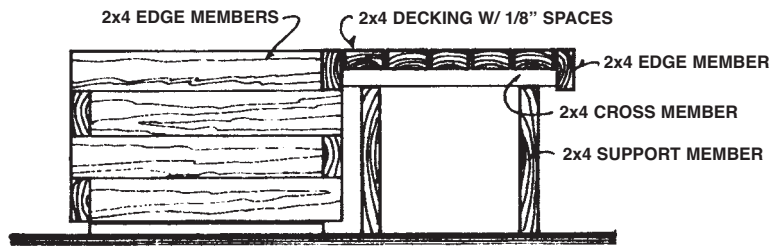
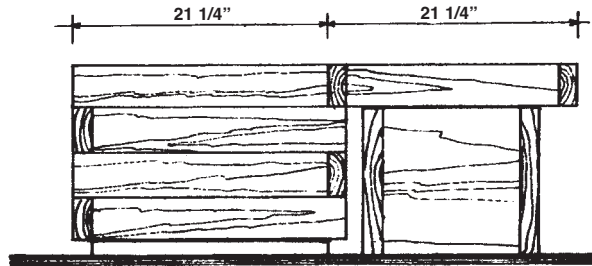
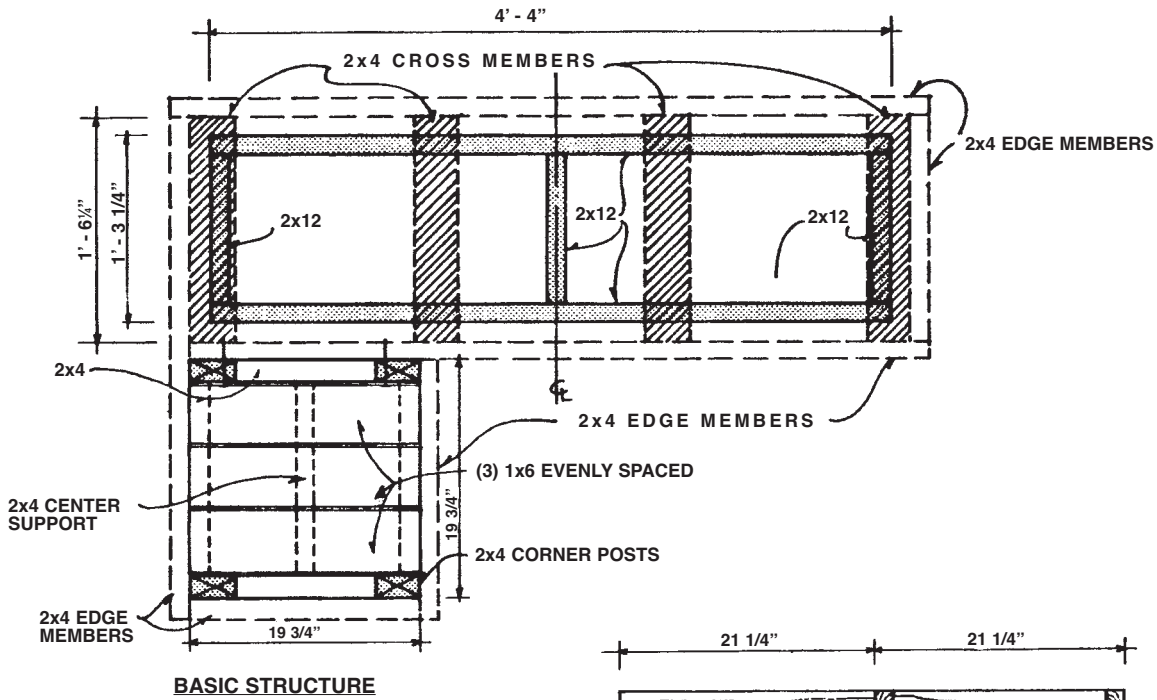

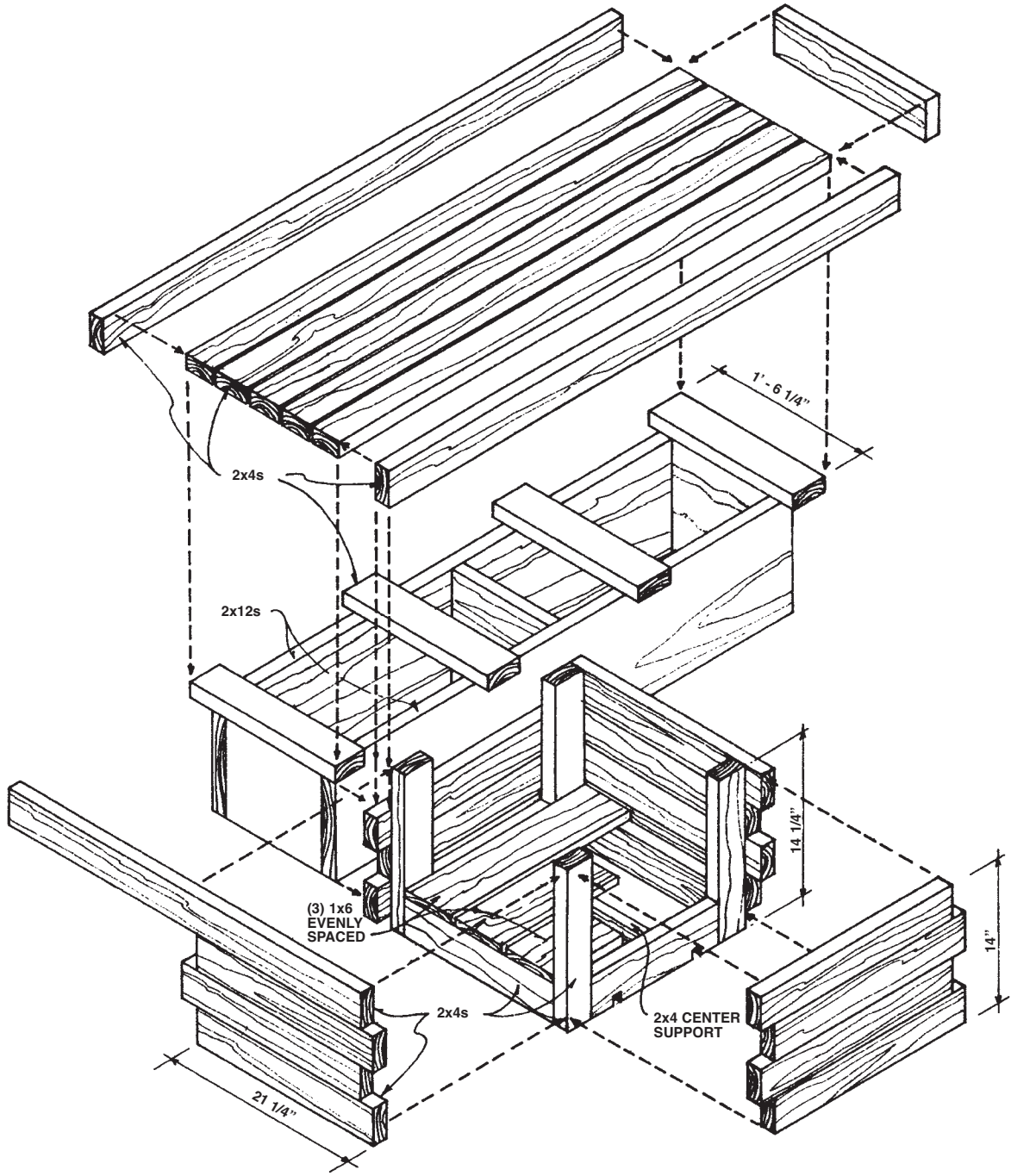

AXONOMETRIC

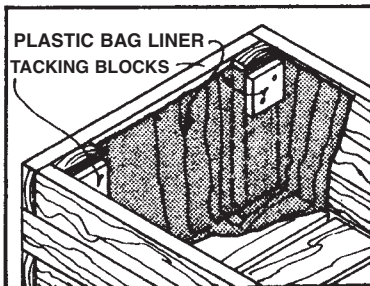

CORNER DETAIL: TACKING BLOCKS



**SOUTHERN
FOREST PRODUCTS
ASSOCIATION**

6660 Riverside Dr., Suite 212
Metairie, LA 70003

SouthernPine.com
SouthernPineDecks.com

Planter Bench

Project Plan #851 Sheet 6 of 6

Copyright © 2016 Southern Forest Products Association. All rights reserved.